

## Digital Transistors (Built-in Resistors)

### DTC143XE/DTC143XUA/DTC143XCA/DTC143XKA

• Equivalent Circuit

DIGITAL TRANSISTOR (NPN)

#### FEATURES

- Built-in bias resistors enable the configuration of an inverter circuit without connecting external input resistors(see equivalent circuit)
- The bias resistors consist of thin-film resistors with complete isolation to allow negative biasing of the input.They also have the advantage of almost completely eliminating parasitic effects
- Only the on/off conditions need to be set for operation, making device design easy

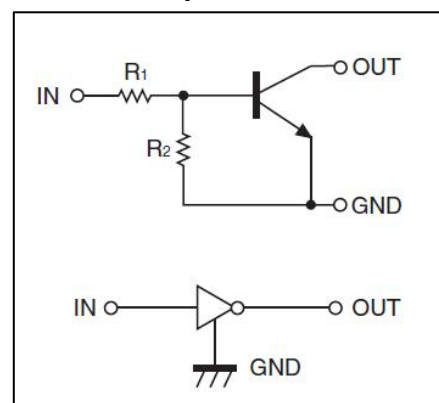

#### PIN CONNENCTIONS and MARKING

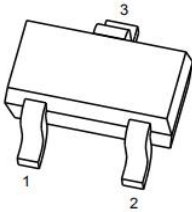
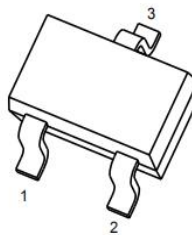
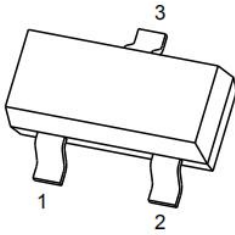
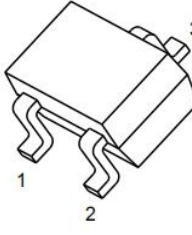
<p><b>DTC143XE</b></p>  <p><b>SOT-523</b></p> <p>1. IN 2. GND 3. OUT</p>	<p><b>DTC143XUA</b></p>  <p><b>SOT-323</b></p> <p>1. IN 2. GND 3. OUT</p>
<p><b>DTC143XCA</b></p>  <p><b>SOT-23</b></p> <p>1. IN 2. GND 3. OUT</p>	<p><b>DTC143XKA</b></p>  <p><b>SOT-23-3L</b></p> <p>1. IN 2. GND 3. OUT</p>

#### ORDERING INFORMATION

Part Number	MARKING	Package	Packing Method	Pack Quantity
DTC143XE	43	SOT-523	Reel	3000pcs/Reel
DTC143XUA	43	SOT-323	Reel	3000pcs/Reel
DTC143XKA	43	SOT-23-3L	Reel	3000pcs/Reel
DTC143XCA	43	SOT-23	Reel	3000pcs/Reel

## MAXIMUM RATINGS(Ta=25°C unless otherwise noted)

Symbol	Parameter	Limits(DTC143X□)						Unit
		M	E	UA	CA	KA	SA	
V <sub>CC</sub>	Supply Voltage	50						V
V <sub>IN</sub>	Input Voltage	-7~+20						V
I <sub>O</sub>	Output Current	100						mA
P <sub>D</sub>	Power Dissipation	100	150	200	200	200	300	mW
T <sub>J</sub>	Junction Temperature	150						°C
T <sub>stg</sub>	Storage Temperature	-55~+150						°C

## ELECTRICAL CHARACTERISTICS (Ta=25°C unless otherwise specified)

Parameter	Symbol	Conditions	Min	Typ	Max	Unit
Input voltage	V <sub>I(off)</sub>	V <sub>CC</sub> =5V, I <sub>O</sub> =100μA	0.3			V
	V <sub>I(on)</sub>	V <sub>O</sub> =0.3V, I <sub>O</sub> =20mA			2.5	V
Output voltage	V <sub>O(on)</sub>	I <sub>O</sub> /I <sub>I</sub> =10mA/0.5mA		0.1	0.3	V
Input current	I <sub>I</sub>	V <sub>I</sub> =5V			1.8	mA
Output current	I <sub>O(off)</sub>	V <sub>CC</sub> =50V, V <sub>I</sub> =0			0.5	μA
DC current gain	G <sub>I</sub>	V <sub>O</sub> =5V, I <sub>O</sub> =10mA	30			
Input resistance	R <sub>1</sub>		3.29	4.7	6.11	kΩ
Resistance ratio	R <sub>2</sub> /R <sub>1</sub>		1.7	2.1	2.6	
Transition frequency	f <sub>T</sub>	V <sub>O</sub> =10V, I <sub>O</sub> =5mA, f=100MHz		250		MHz

## Typical Characteristics

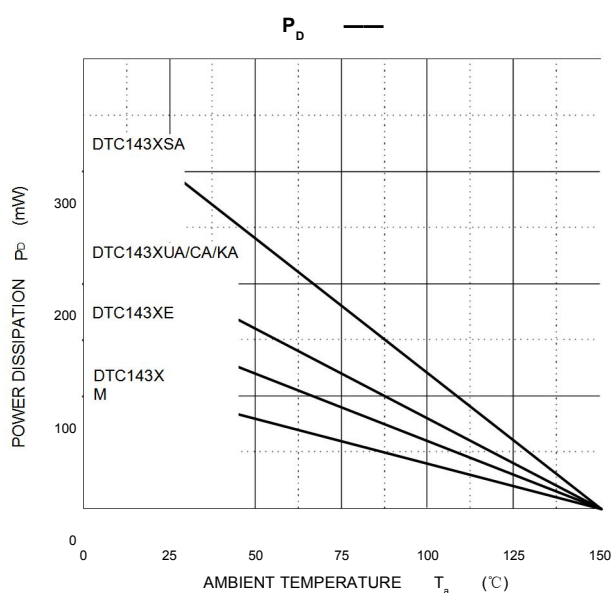
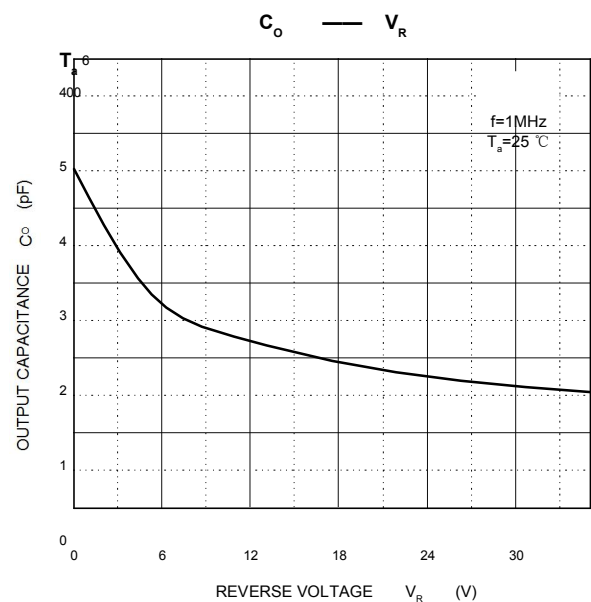
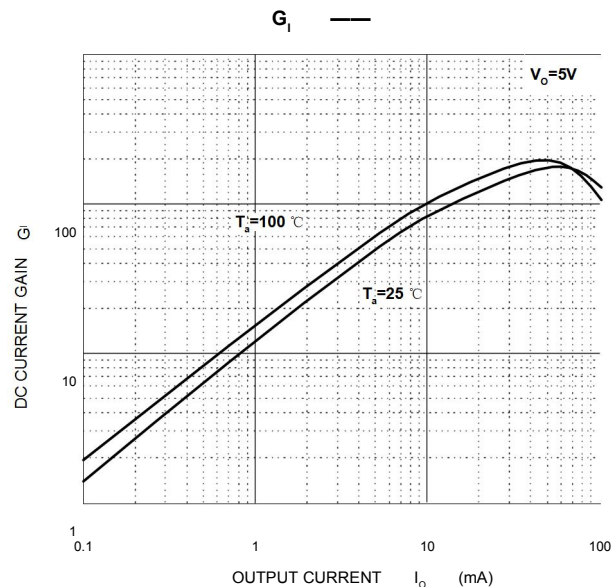
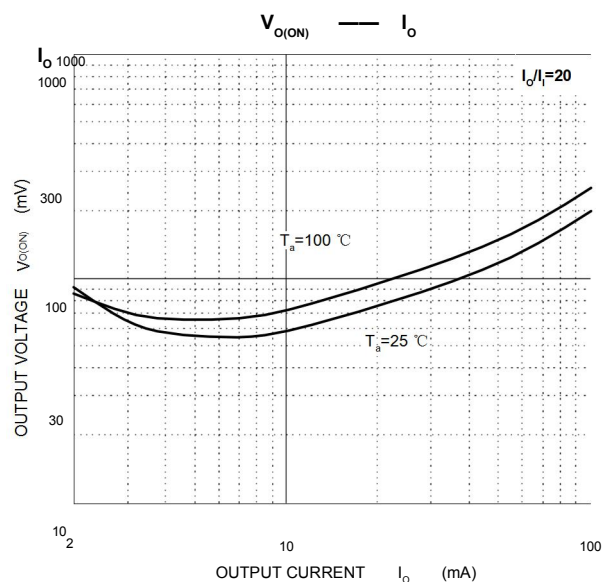
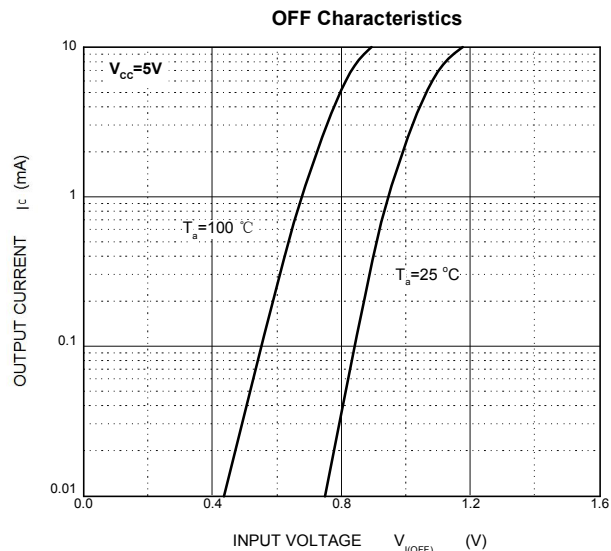
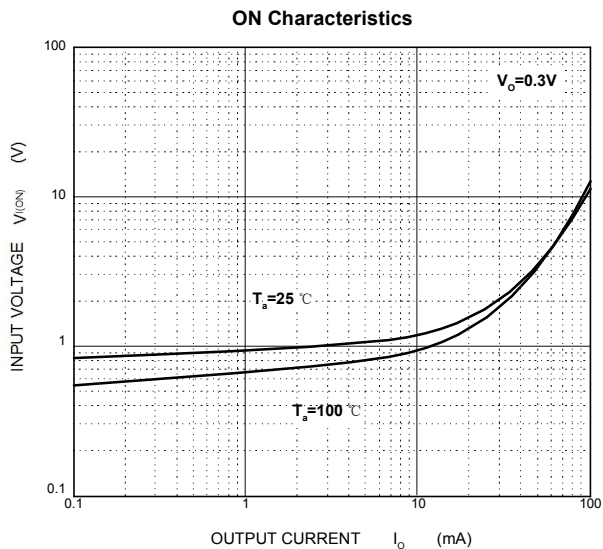

## SOT-523 Package Outline Dimensions

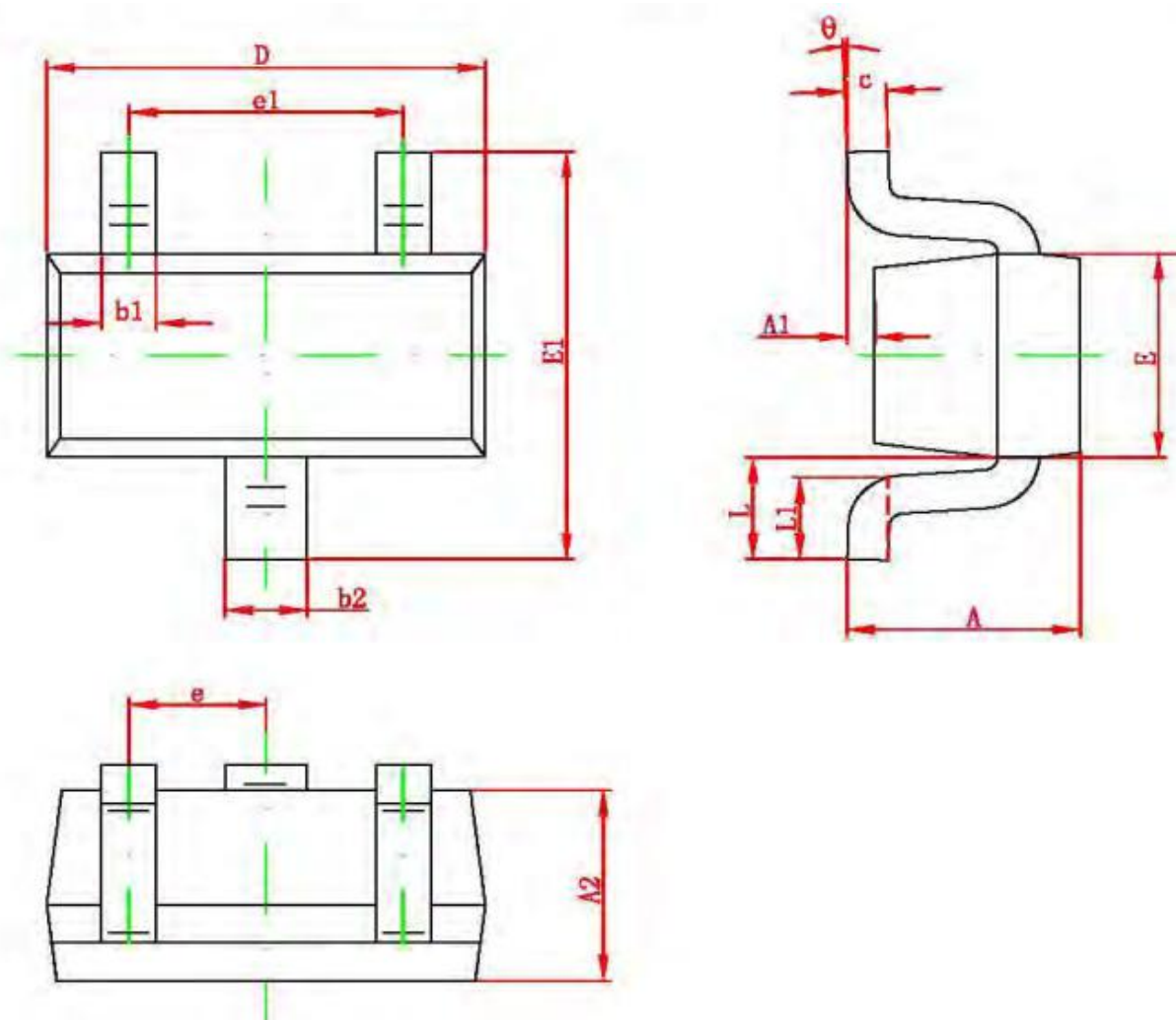

Symbol	Dimensions In Millimeters		Dimensions In Inches	
	Min.	Max.	Min.	Max.
A	0.700	0.900	0.028	0.035
A1	0.000	0.100	0.000	0.004
A2	0.700	0.800	0.028	0.031
b1	0.150	0.250	0.006	0.010
b2	0.250	0.350	0.010	0.014
c	0.100	0.200	0.004	0.008
D	1.500	1.700	0.059	0.067
E	0.700	0.900	0.028	0.035
E1	1.450	1.750	0.057	0.069
e	0.500 TYP.		0.020 TYP.	
e1	0.900	1.100	0.035	0.043
L	0.400 REF.		0.016 REF.	
L1	0.260	0.460	0.010	0.018
θ	0°	8°	0°	8°

## SOT-323 Package Outline Dimensions

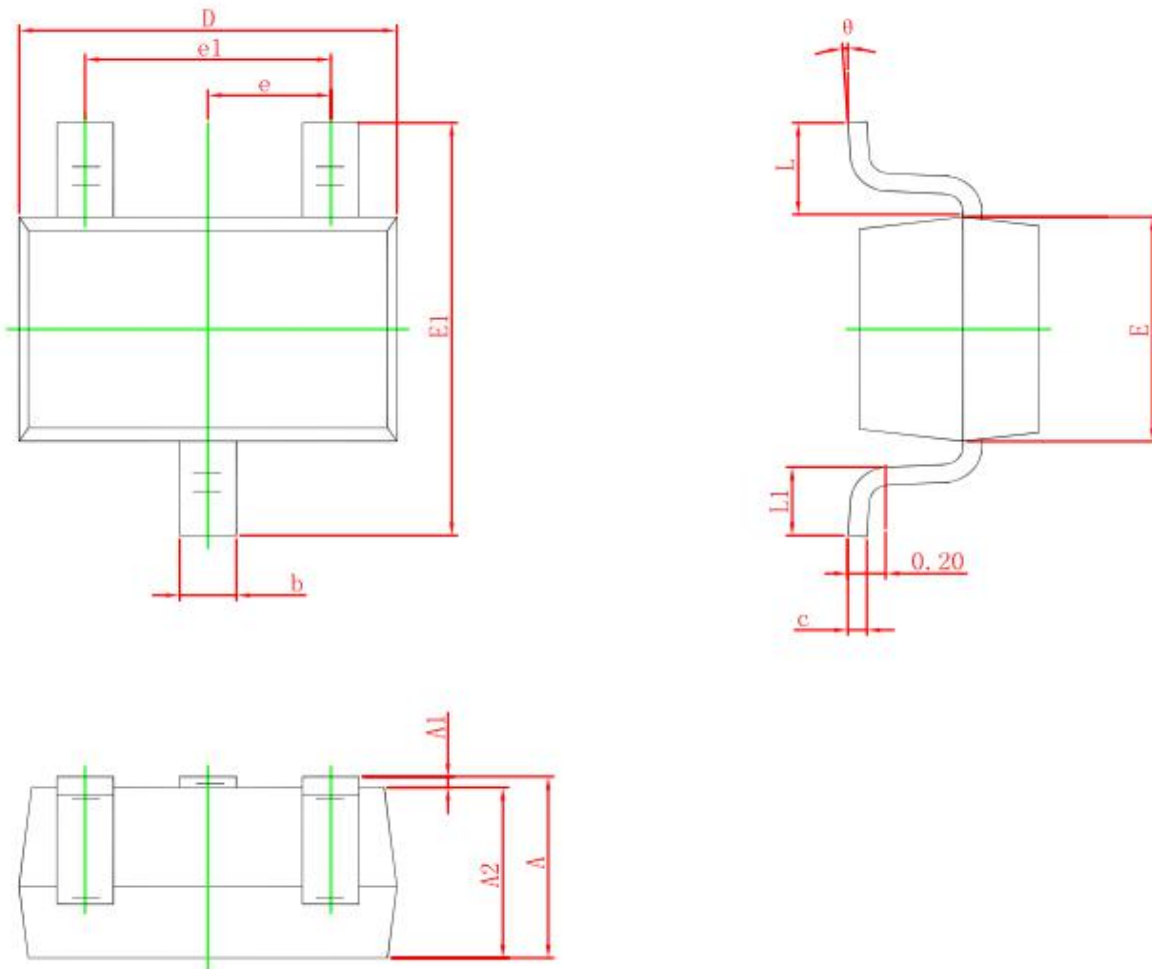

Symbol	Dimensions In Millimeters		Dimensions In Inches	
	Min.	Max.	Min.	Max.
A	0.900	1.100	0.035	0.043
A1	0.000	0.100	0.000	0.004
A2	0.900	1.000	0.035	0.039
b	0.200	0.400	0.008	0.016
c	0.080	0.150	0.003	0.006
D	2.000	2.200	0.079	0.087
E	1.150	1.350	0.045	0.053
E1	2.150	2.450	0.085	0.096
e	0.650 TYP.		0.026 TYP.	
e1	1.200	1.400	0.047	0.055
L	0.525 REF.		0.021 REF.	
L1	0.260	0.460	0.010	0.018
$\theta$	0°	8°	0°	8°

## SOT-23 Package Outline Dimensions

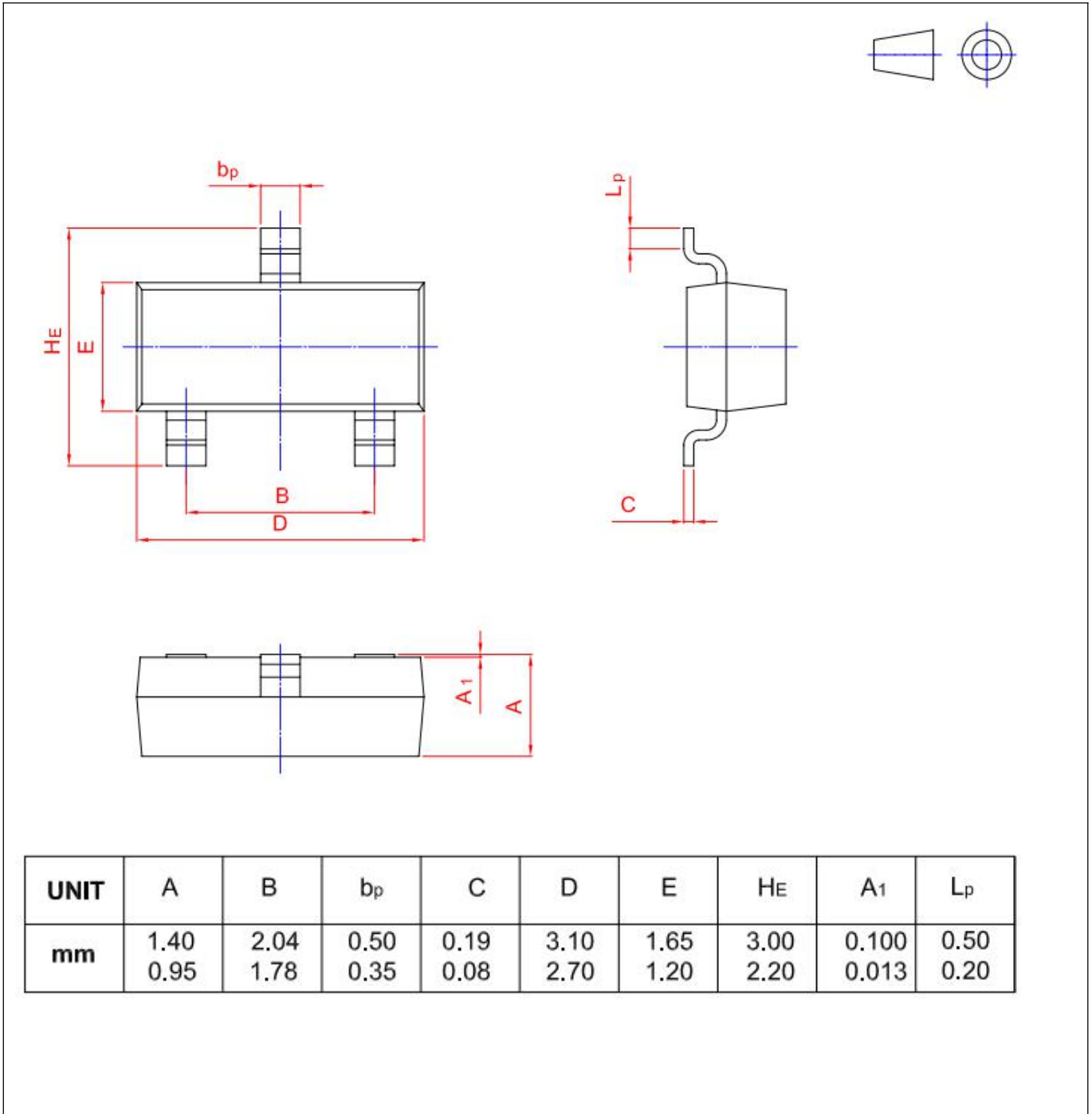

## SOT23-3L Package Outline Dimensions

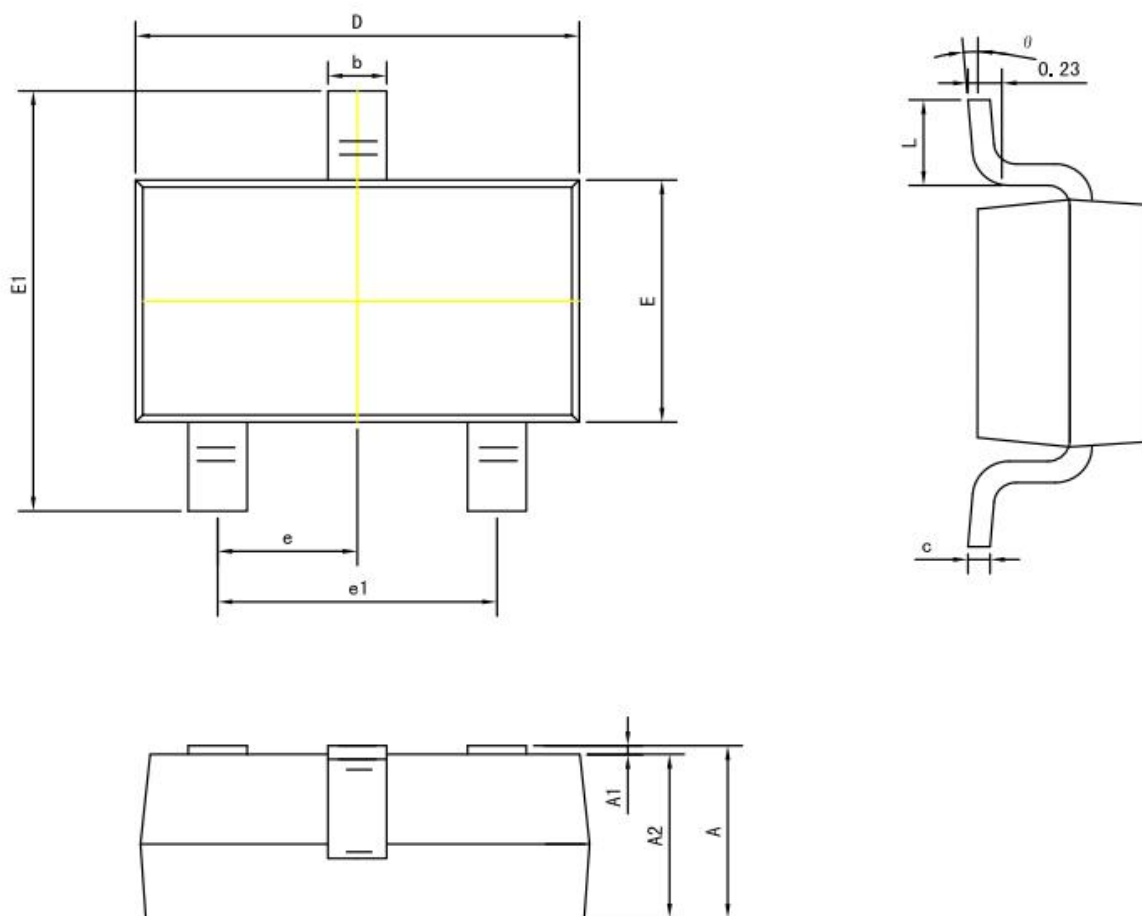

Symbol	Dimension in Millimeters		
	Min	Typ	Max
A	1.050	1.150	1.250
A1	0.000	0.050	0.100
A2	1.050	1.100	1.150
b	0.300	0.400	0.500
c	0.100	0.150	0.200
D	2.820	2.920	3.020
E	1.500	1.600	1.700
E1	2.650	2.800	2.950
e	0.950 (Basic)		
e1	1.800	1.900	2.000
L	0.300	-	0.600
$\theta$	0°	-	8°